











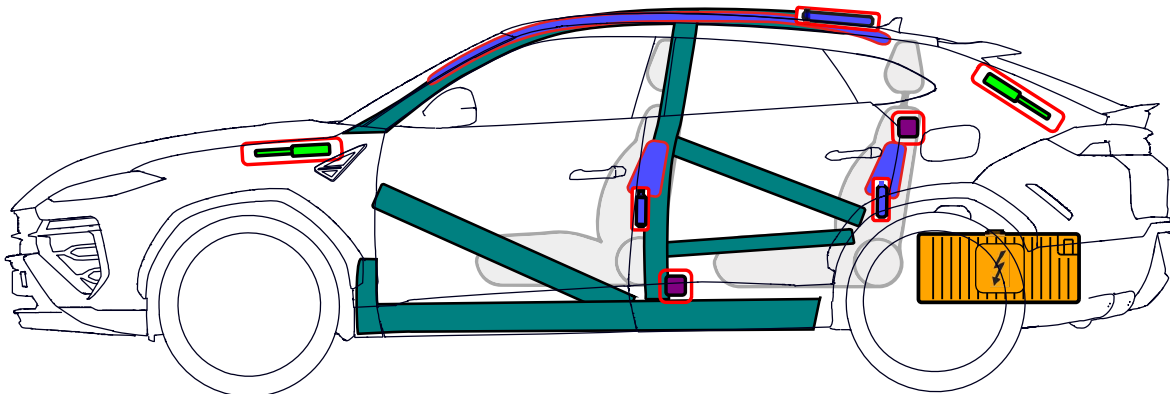
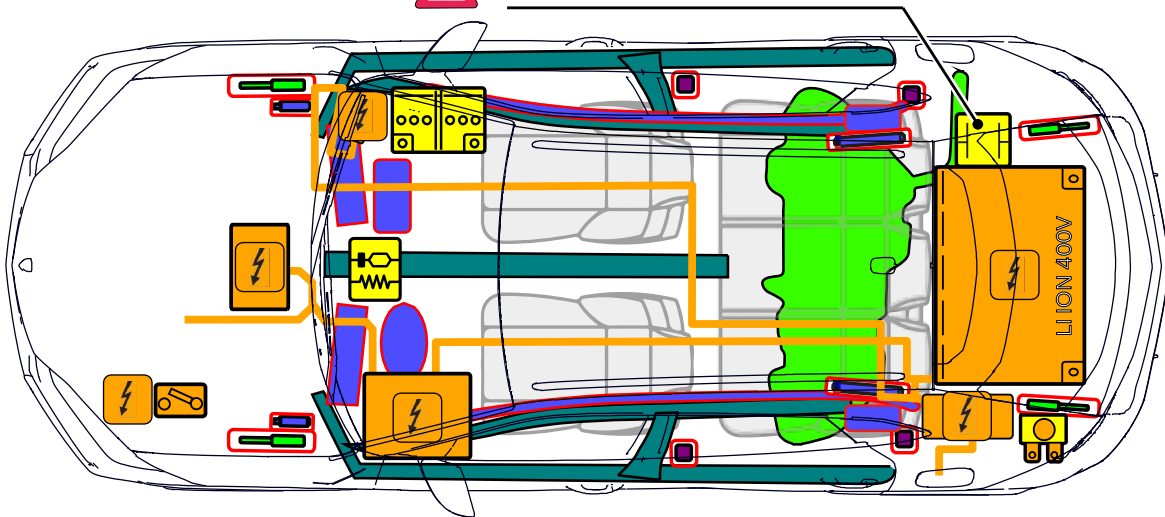





# Lamborghini Urus SE

## V8 PHEV



 Caution **48 V** Turn off the ignition!



- |   |                           |   |                          |   |                        |   |                          |   |  |
|---|---------------------------|---|--------------------------|---|------------------------|---|--------------------------|---|--|
|  | Airbag                    |  | Stored gas inflator      |  | Seat belt pretensioner |  | Gas strut                |  | Fuse box disabling high voltage system |
|  | Fuel tank                 |  | SRS control              |  | Reinforcement          |  | Battery unit low voltage |  | Condenser                              |
|  | High voltage battery pack |  | High voltage power cable |  | High voltage component |  | High voltage disconnect  |   |  |

- Complete aluminum body.
- Conventional reinforcements are used in the doors.



# Lamborghini Urus SE

## V8 PHEV

### 1. Identification / recognition



When the vehicle is in EV mode, the electric traction will not emit a traditional engine sound, but when the gear selector is in a position other than P, the vehicle will begin to move as soon as the accelerator is pressed.

If the vehicle is in the park position "P," the electric drive will activate when "READY" is displayed on the instrument cluster.

When the vehicle is not in the park position, an "E" is displayed on the instrument cluster to indicate that the electric traction is active.



Lettering  
**Urus SE**

Charging  
socket





# Lamborghini Urus SE

## V8 PHEV

### 2. Immobilization / stabilization / lifting

#### Manual Activation and Deactivation of the Parking Brake

- Pull the button (1) to activate the parking brake. The LED integrated in the button will illuminate. Additionally, the warning light will turn on in the instrument cluster.
- To manually deactivate the parking brake, with the instrument cluster on, press the brake pedal and simultaneously press the button (1). The LED integrated in the button and the warning light in the instrument cluster will turn off.



#### Switching off the ignition



- Stop the vehicle.
- Press the START ENGINE STOP button (1).
- The electric traction and the internal combustion engine will be turned off.

#### Lifting points

The figure below shows the lifting points for URUS SE

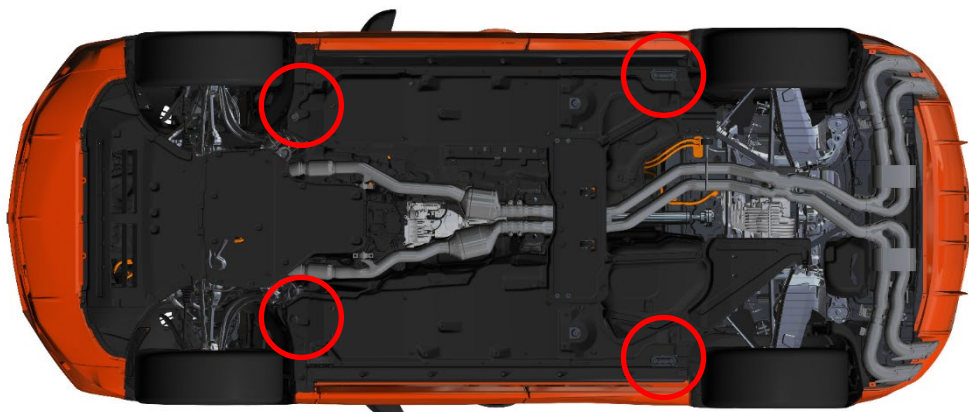



# Lamborghini Urus SE

## V8 PHEV

### 3. Disable direct hazards / safety regulations

In the event of an accident in which the airbag is triggered, the high voltage system is automatically deactivated as soon as airbag triggering is detected.



Do not touch, cut or open damaged high voltage components, cables and high voltage batteries!

If touching high voltage cables and other high voltage components is unavoidable, personal protective equipment (insulating gloves, goggles, and boots) should always be worn.

In all other cases, the high voltage system can be deactivated as follows:

#### 1. Option 1: Service disconnect

- Open the front bonnet.
- Raise the cover assembly (1), remove the safety tab (2) and then extract the connector (3) until it stops.

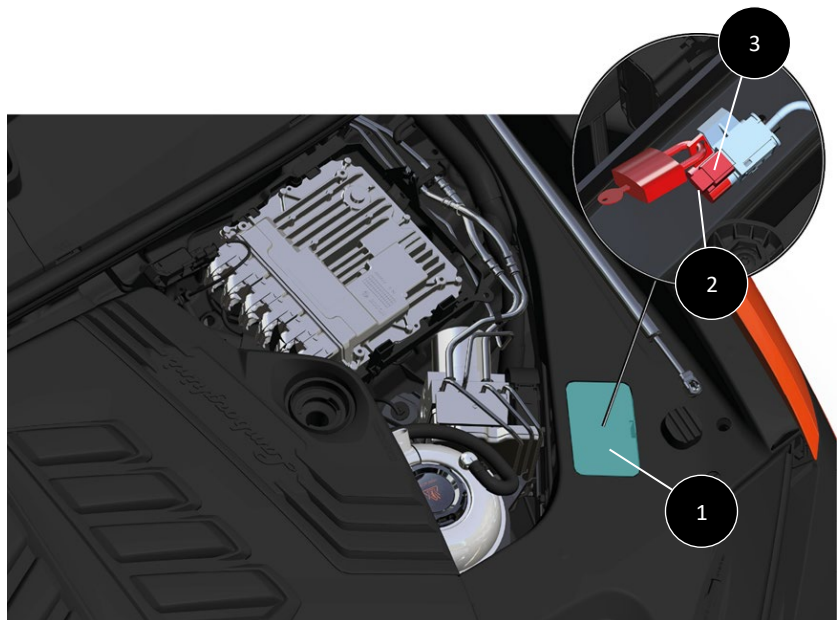

#### 2. SK2 fuse

In addition to the procedure above, to carry out the HV system deactivation, follow the steps below:

1. Open the tailgate.
2. Remove fuse box cover lid in the rear left trunk area.
3. Remove the cover of the specific fuse holder.
4. Remove the SK2 fuse.

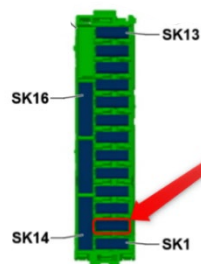
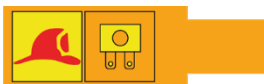





# Lamborghini Urus SE

## V8 PHEV

### 12V battery disconnection

Follow the steps below to disconnect the 12V battery:

1. Switch off the ignition with the "START ENGINE STOP" button on the central console.
2. Remove the passenger footwell carpet and remove the battery cover.



3. Loosen the nut by a few turns and remove the ground cable clamp from the negative battery terminal.
  - After the clamp has been disconnected, make sure it cannot accidentally contact the negative terminal on the battery.

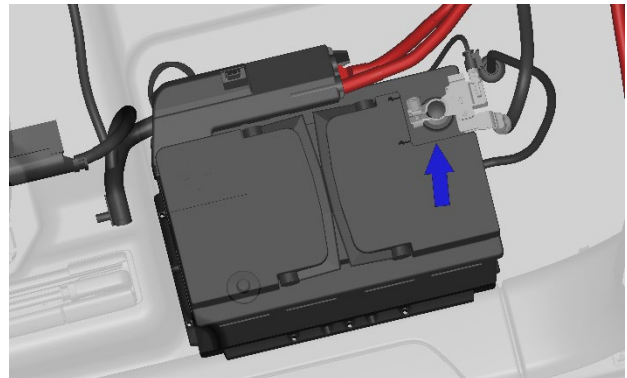

### Disconnecting from the charging station (manual release of charging connector)

If you are unable to disconnect the charging plug from the vehicle's socket, there may be an issue. You must perform the emergency release of the vehicle's charging plug.

- To unlock the charging plug, the gear selector must be in position P.
- Complete the charging process.
- Open the rear hatch.
- Remove the cover of the glove compartment (1) and gently pull the emergency cable (2).
- Extract the charging plug.





# Lamborghini Urus SE

## V8 PHEV

### 4. Access to the occupants

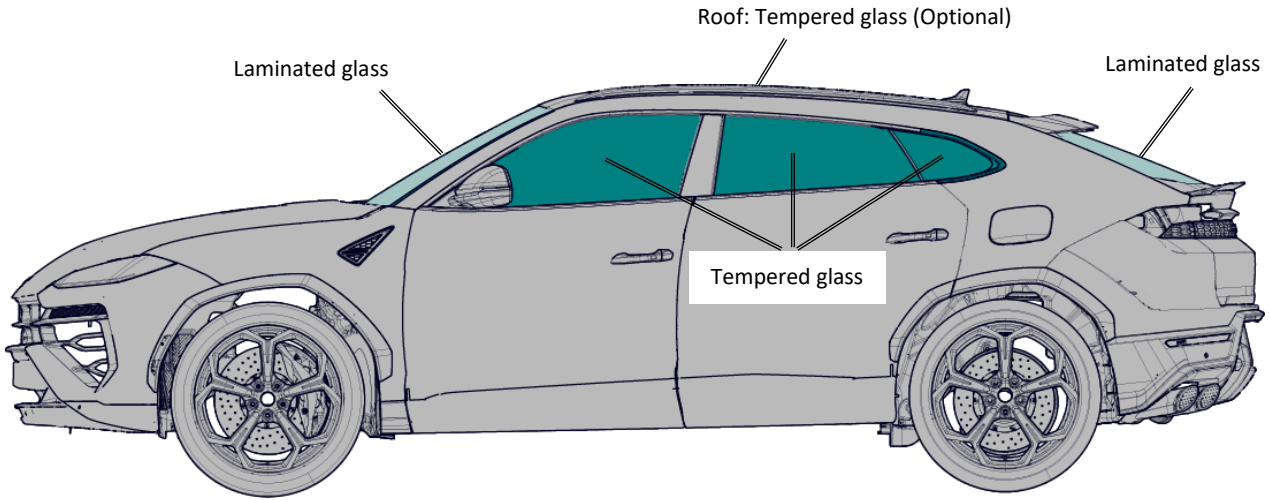

### 5. Stored energy / liquids / gases / solids

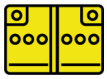

12 V



400 V



If coolant leaks from the battery cooling system, there is a risk of a thermal reaction in the high voltage battery.

Monitor the temperature of the high voltage battery!



### 6. In case of fire



Lithium-ion batteries can self-ignite either immediately or after a delay when damage occurs or they are not used properly, or re-ignite after fire-fighting measures.

Wear appropriate personal protective equipment!



### 7. In case of submersion

After recovering the vehicle from the water, deactivate the high voltage system (see chapter 3) and drain the water. Wear appropriate personal protective equipment!



# Lamborghini Urus SE

## V8 PHEV

### 8. Towing / transportation / storage



Lithium-ion batteries can self-ignite or re-ignite after fire-fighting measures!  
Wear appropriate personal protective equipment!



In the event that vehicles that have been in accidents have a damaged battery or the battery exhibits anomalies: disable the high voltage system (see chapter 3). Park the vehicle at a safe distance of at least 5 m from buildings and other vehicles (quarantine area).

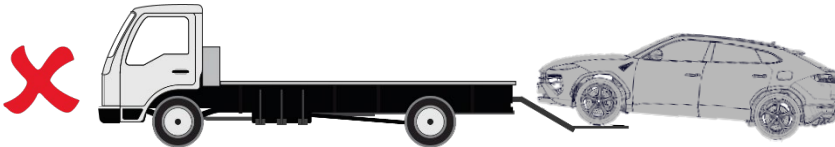
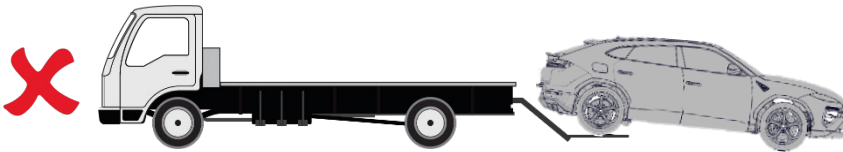
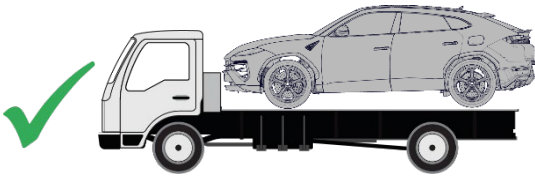

Do not tow away a vehicle that was in an accident by the drive axles.

### 9. Important additional information

### 10. Explanation of pictograms used



Flammable



Corrosives



Hazardous to human health



Environmental hazard



Electric vehicle



Warning. Electricity



General warning sign



Use water to the extinguish the fire



Use thermal infrared camera